

CENTRIFUGE CENTRIC 260 R

High speed centrifuges

User-friendly instrument with rounded edges. The modern interface offers a clear view of parameters, ensuring precise and efficient lab work. Experience the future of refrigerated centrifugation.



TECHNICAL SPECIFICATIONS	
Model	Centric 260 R
Max. G force	31.150 rcf
Rotational speed	200 to 18.000 rpm, step of 10 rpm
Max. capacity	
Angle rotor	6 x 50 ml
Swing out rotor	6 x 12 ml
Rotors available	10
Acceleration levels	10
Deceleration levels	10 (level 0 without braking)
Display	LED
Timer	10 s to 99 min and continuous, step 10 s
Fast spin with preselected speed	yes
Temperature set range	-19°C to +40°C, step 1°C
Fast cooling from 20°C to 4°C	in approximately 5-10 minutes
Max. power consumption	1050 W
Noise level(at max. speed)	< 56 dB(A)
Dimension (H x W x D)	288 x 360 x 675 mm
Crating (H x W x D)	440 x 570 x 780 mm
Weight (Net/Crated)	50,0 / 58,0 kg
Height (with open lid)	606 mm
Program settings	100 programs
Lid locking mechanism	motorized
Lid lock	2 latches
Motor type	induction brushless motor
Permitted working ambient	"temperature 2°C to 35°C, rh 75% non-condensing"

ORDER INFORMATION	
230 V, 50/60 Hz	Centric 260 R
Code	472.500
Order ref.	371675
230 V, 50/60 Hz	Centric 260 R
Code	472.500/UK
Order ref.	466528
120 V, 50/60 Hz	Centric 260 R 120 V
Code	1.472.500
Order ref.	416205



For more information visit Domel website: <https://labs.domel.com> / Technical specifications subject to change.

*The time may vary at different rotors, loads or voltage

Available only outside EU

ANGLE ROTOR RA 8/15

Up to 8 x 15 ml centrifuge tubes
Shields included

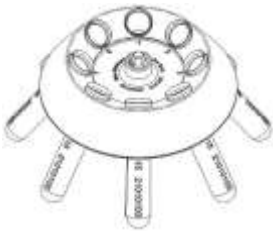

Rotor specifications	RA 8/15
Max. Speed	6.000 rpm
Max. G force	4.020 rcf
Radius	110 mm
Angle	40°
Max. capacity	8 x 15 ml
Min. acceleration time*	25 s
Min. braking time*	27 s
Rotor and shields autoclavable	yes

Code	472.950
Order ref.	448807

Spare shields(set of 8)	B 15 SS
Code	472.956
Order ref.	448817





	Blood collection tubes	Blood collection tubes	Blood collection tubes	Conical tubes
Nominal volume	5 ml	7 - 10 ml	10 - 12 ml	15 ml
Tube dimensions (d x l)	13 x 75 mm	13 x 100 mm	16 x 100 mm	17 x 120 mm
Adapter	A 5	/	/	/
No. of tubes / rotor	8	8	8	8
No. of adapters / rotor	8	0	0	0
Code				
Order ref.				

ANGLE ROTOR RA 24/2

Up to 24 x 2 ml centrifuge microtubes
Lid included



Rotor specifications	RA 24/2
Max. Speed	18.000 rpm
Max. G force	31.150 rcf
Radius	86 mm
Angle	45°
Max. capacity	24 x 2,0 ml
Min. acceleration time*	27 s
Min. braking time*	28 s
Rotor and lid autoclavable	yes
Code	456.600
Order ref.	228442



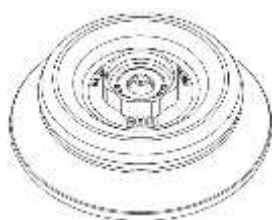

	PCR tubes	PCR tubes	Microtubes
			
Nominal volume	0,2/0,4 ml	0,5 ml	1,5 - 2,0 ml
Tube dimensions (d x l)	6 x 18 mm	8 x 30 mm	11 x 38 mm
			
Adapter	A 0,2	A 0,5	/
No. of tubes / rotor	24	24	24
No. of adapters / rotor	24	24	0
Code	456.625	456.626	/
Order ref.	284351	284349	/

ANGLE ROTOR RA 24/2 AEROSOL

Up to 24 x 2 ml centrifuge microtubes
Aerosol - Tight lid included



Rotor specifications	RA 24/2 AEROSOL
Max. Speed	18.000 rpm
Max. G force	31.150 rcf
Radius	86 mm
Angle	45°
Max. capacity	24 x 2,0 ml
Min. acceleration time*	26 s
Min. braking time*	28 s
Rotor and lid autoclavable	yes
Code	473.400
Order ref.	375944



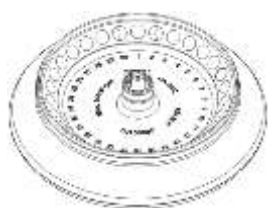

	PCR tubes	PCR tubes	Microtubes
			
Nominal volume	0,2/0,4 ml	0,5 ml	1,5 - 2,0 ml
Tube dimensions (d x l)	6 x 18 mm	8 x 30 mm	11 x 38 mm
			
Adapter	A 0,2	A 0,5	/
No. of tubes / rotor	24	24	24
No. of adapters / rotor	24	24	0
Code	456.625	456.626	/
Order ref.	284351	284349	/

ANGLE ROTOR RA 30/2

Up to 30 x 2 ml centrifuge microtubes
Lid included



Rotor specifications	RA 30/2
Max. Speed	14.000 rpm
Max. G force	21.450 rcf
Radius	98 mm
Angle	45°
Max. capacity	30 x 2,0 ml
Min. acceleration time*	27 s
Min. braking time*	27 s
Rotor and lid autoclavable	yes
Code	456.620
Order ref.	228451

	PCR tubes	PCR tubes	Microtubes
			
Nominal volume	0,2/0,4 ml	0,5 ml	1,5 - 2,0 ml
Tube dimensions (d x l)	6 x 18 mm	8 x 30 mm	11 x 38 mm
			
Adapter	A 0,2	A 0,5	/
No. of tubes / rotor	30	30	30
No. of adapters / rotor	30	30	0
Code	456.625	456.626	/
Order ref.	284351	284349	/



SWING OUT ROTOR RS 6/12

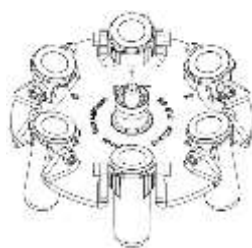

Up to 6 x 12 ml centrifuge tubes
Buckets included



Rotor specifications	RS 6/12
Max. Speed	4.400 rpm
Max. G force	2.160 rcf
Radius	63 mm
Angle	90°
Max. capacity	6 x 12 ml
Min. acceleration time*	25 s
Min. braking time*	28 s
Rotor and buckets autoclavable	yes
Code	472.810
Order ref.	398241

Spare buckets(set of 6)	B 12 PA
Code	472.357
Order ref.	412009

	Blood collection tubes	Blood collection tubes	Blood collection tubes
			
Nominal volume	5 ml	7 - 10 ml	10 - 12 ml
Tube dimensions (d x l)	13 x 75 mm	13 x 100 mm	16 x 100 mm
No. of tubes / rotor	6	6	6

	Blood collection tubes	Blood collection tubes	Blood collection tubes
			
Nominal volume	5 ml	7 - 10 ml	10 - 12 ml
Tube dimensions (d x l)	13 x 75 mm	13 x 100 mm	16 x 100 mm
No. of tubes / rotor	6	6	6

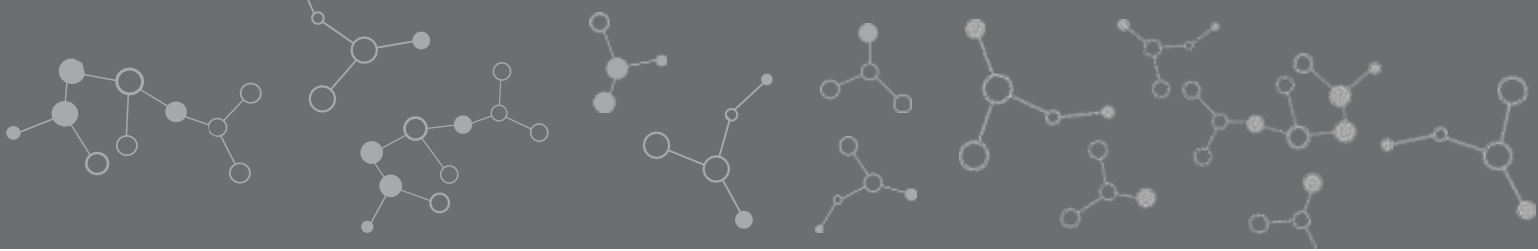



ANGLE ROTOR RA 6/50

Up to 6 x 50 ml centrifuge tubes
Shields included



Rotor specifications	RA 6/50
Max. speed	6.000 rpm
Max. G force	3.620 rcf
Radius	110 mm
Angle	45°
Max. capacity	6 x 50 ml
Min. acceleration time	25 s
Min. braking time	28 s
Rotor and shields autoclavable	yes
Code	472.940
Order ref.	448806

	Conical tubes	Conical tubes
		
Nominal volume	15 ml	50 ml
Tube dimensions (d x l)	17 x 120 mm	30 x 115 mm
		
Adapter	A 15	/
No. of tubes / rotor	6	6
No. of adapters / rotor	6	/
Code	464.330	/
Order ref.	462092	/

ANGLE ROTOR RA 16/5

Up to 16 x 5 ml centrifuge microtubes
Lid included

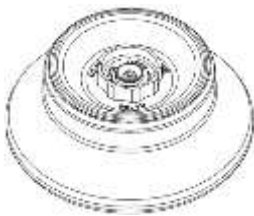

Rotor specifications	RA 16/5
Max. speed	14.000 rpm
Max. G force	21.450 rcf
Radius	98 mm
Angle	45°
Max. capacity	16 x 5,0 ml
Min. acceleration time	26 s
Min. braking time	27 s
Rotor and lid autoclavable	yes
Code	472.890
Order ref.	403055

	Microtubes
	
Nominal volume	5ml
Tube dimensions (d x l)	15,6 x 60 mm
Adapter	/
No. of tubes / rotor	16

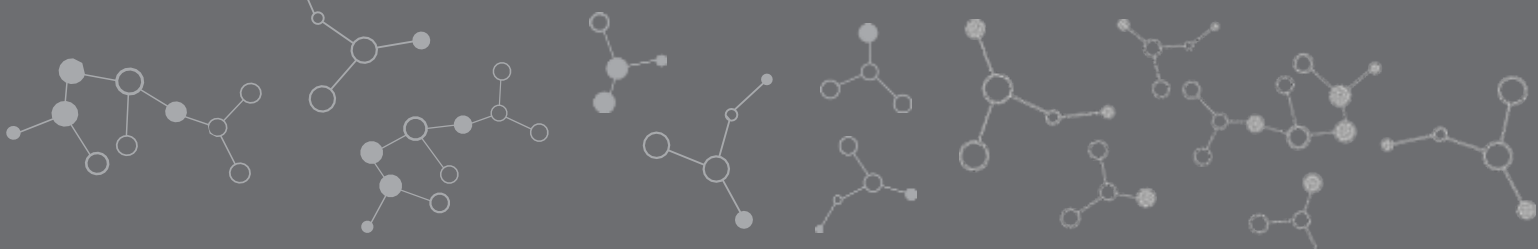

ANGLE ROTOR RA 6/PCR

Up to 6 PCR strips

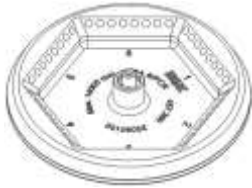

Rotor specifications	RA 6/PCR
Max. speed	14.000 rpm
Max. G force	19.500 rcf
Radius	98 mm
Angle	45°
Max. capacity	6 x 8 PCR strip
Min. acceleration time	26 s
Min. braking time	28 s
Rotor and lid autoclavable	yes
Code	457.380
Order ref.	273335

8 Well PCR tube strip	
Nominal volume	0,2 ml
No. of tubes / rotor	48

SWING-OUT ROTOR RM 2/2

Up to 4 x MTP
MTP Carriers included



Rotor specifications	RM 2/2
Max. speed	5.700 rpm
Max. G force	3.000 rcf
Radius	85 mm
Angle	90°
Max. capacity	4 x MTP
Min. acceleration time	24 s
Min. braking time	28 s
Rotor autoclavable	yes
Code	472.903
Order ref.	429192

Standard MTP	
Nominal volume	96 x 220 µl 96 x 270 µl 96 x 350 µl
Plate dimensions (d x l x h)	128 x 86 x 15 mm
No. of MTP / rotor	4